

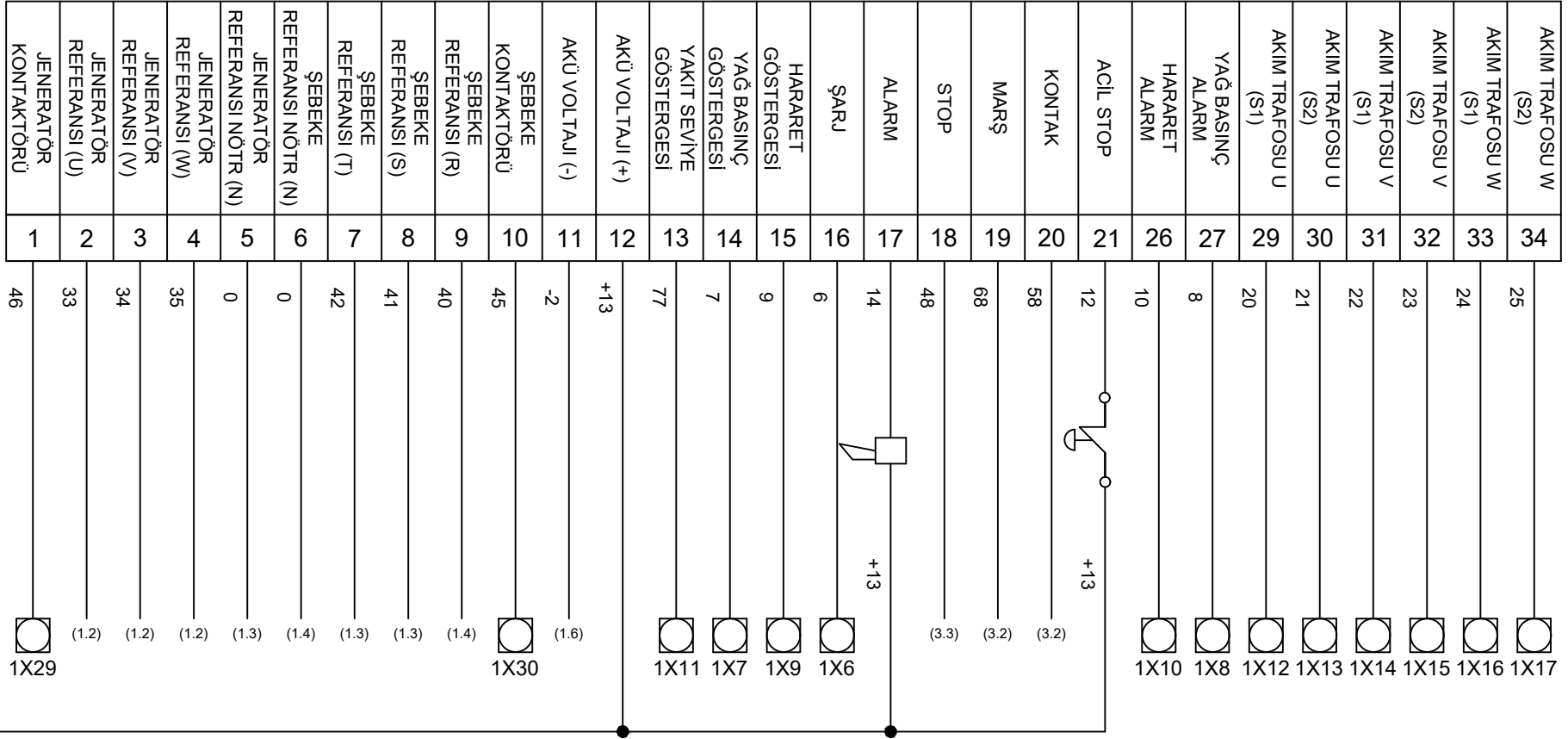

IWAS JTP 309



+13 (1.5)

NOTE : DO NOT SCALE.

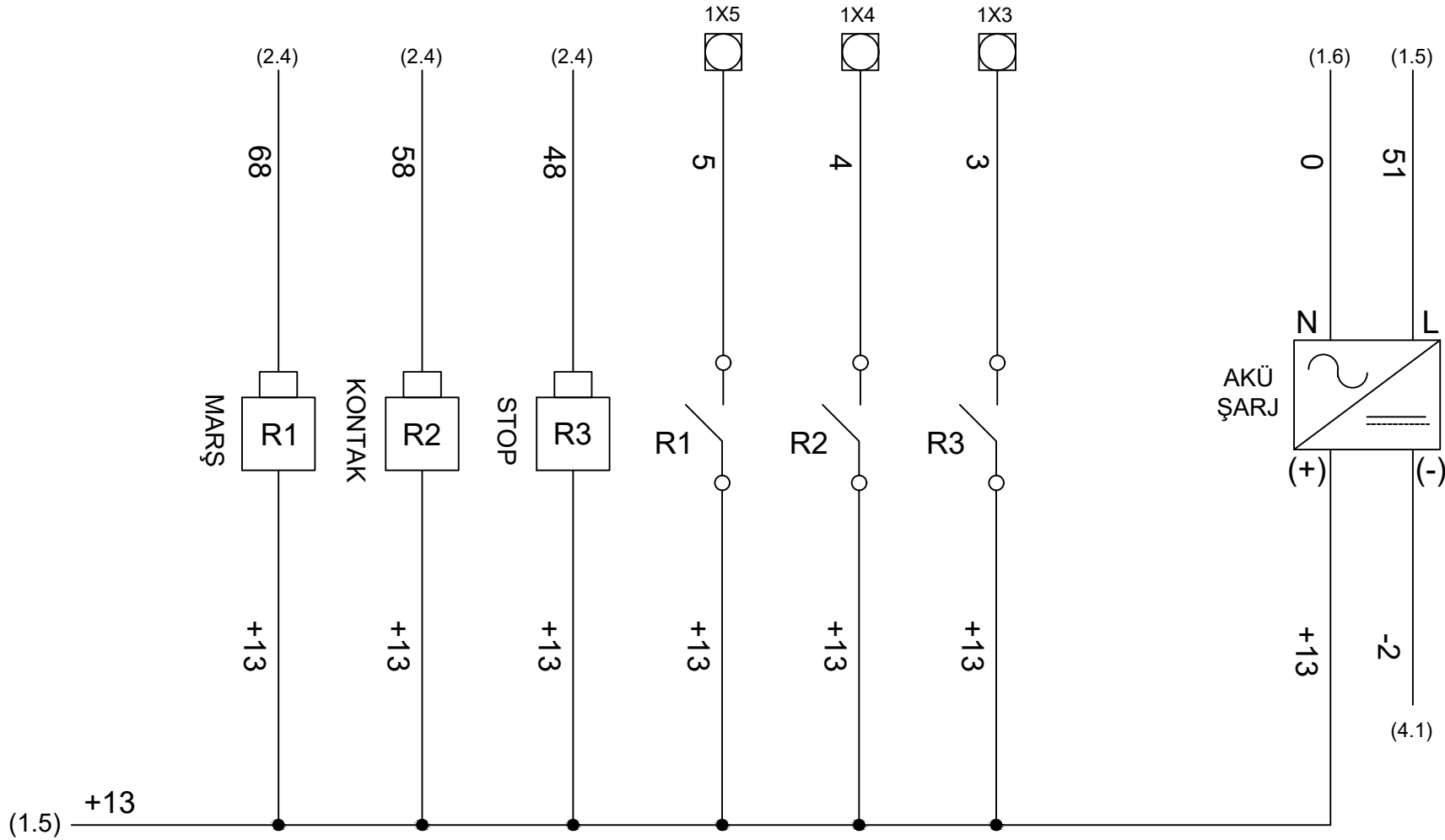

| | | | | | |
|--------|-----------------------|-----|-----|----|------|
| DOC NO | DESCRIPTION | ECO | REV | BY | DATE |
| 1 | REFERENCE DOCUMENTS | | A | | |
| 2 | REVISIONS | | | | |
| 3 | YAYIMLANDI (RELEASED) | | | | |

| | | | | | |
|---|---|-------------|------|---|---|
| METRIC | | APPROVED BY | DATE |  | SARAY MAH. AKSOY CAD NO:71/C KAHRAMANKAZAN / ANKARA TEL: 0312 394 05 03 MAIL: info@daspower.com.tr WEB: www.daspower.com.tr |
| PROJECT NUMBER | Ö.KABA | 02.03.2021 | | | |
| PROJECT NAME | Ö.KABA | 02.03.2021 | | PART DESCRIPTION | |
| GENERAL TOLERANCES PER ISO 2768 | Ö.KABA | 02.03.2021 | | IWAS JTP 309 BAĞLANTILARI | |
| UNLESS OTHERWISE SPECIFIED ALL DIMENSIONS ARE IN MILLIMETERS SURFACE FINISH ARE IN MICROMETERS R _a | Ö.KABA | 02.03.2021 | | SIZE | SCALE |
| MATERIAL | THIS DOCUMENT IS PROPERTY OF GENPOWER GENERATOR INC. ALL RIGHTS ARE RESERVED. | | | A3 | 1:2 |
| WEIGHT (kg) | FIRST ANGLE PROJECTION | AX NO: | | SHEET | 2 / 5 |
| | | | | PART NUMBER | REV |
| | | | | CONFIGURATION | A |



NOTE : DO NOT SCALE.



| DOC NO | DESCRIPTION | ECO | REV | BY | DATE |
|--------|---------------------|-----|-----|----|------|
| 1 | REFERENCE DOCUMENTS | | | | |
| 2 | REVISIONS | | | | |
| 3 | | | | | |

| | | | | | |
|---|--|-------------|------|---|---|
| METRIC | | APPROVED BY | DATE |  | SARAY MAH. AKSOY CAD NO:71/C KAHRAMANKAZAN / ANKARA TEL: 0312 394 05 03 MAIL: info@daspower.com.tr WEB: www.daspower.com.tr |
| PROJECT NUMBER | Ö.KABA | 02.03.2021 | | | |
| PROJECT NAME | CHECKED BY | DATE | | | |
| GENERAL TOLERANCES PER ISO 2768 | Ö.KABA | 02.03.2021 | | PART DESCRIPTION | |
| UNLESS OTHERWISE SPECIFIED ALL DIMENSIONS ARE IN MILLIMETERS SURFACE FINISH ARE IN MICROMETERS R _a | Ö.KABA | 02.03.2021 | | RÖLE VE AKÜ ŞARJ BAĞLANTILARI | |
| MATERIAL | THIS DOCUMENT IS PROPERTY OF GENPOWER GENERATOR INC. ALL RIGHTS ARE RESERVED. | | | SIZE | SCALE |
| WEIGHT (kg) | FIRST ANGLE PROJECTION  | | | A3 | 1:2 |
| | AX NO: | | | SHEET | 3 / 5 |
| | | | | PART NUMBER | REV |
| | | | | CONFIGURATION | A |

| | | | |
|------|--------------------------|----|-------------------------|
| 1X1 | <input type="checkbox"/> | +1 | AKÜ VOLTAJI (+) |
| 1X2 | <input type="checkbox"/> | -2 | AKÜ VOLTAJI (-) |
| 1X3 | <input type="checkbox"/> | 3 | STOP |
| 1X4 | <input type="checkbox"/> | 4 | KONTAK |
| 1X5 | <input type="checkbox"/> | 5 | MARŞ |
| 1X6 | <input type="checkbox"/> | 6 | ŞARJ |
| 1X7 | <input type="checkbox"/> | 7 | YAĞ BASINÇ GÖSTERGESİ |
| 1X8 | <input type="checkbox"/> | 8 | YAĞ BASINÇ ALARM |
| 1X9 | <input type="checkbox"/> | 9 | HARARET GÖSTERGESİ |
| 1X10 | <input type="checkbox"/> | 10 | HARARET ALARM |
| 1X11 | <input type="checkbox"/> | 77 | YAKIT SEVİYE GÖSTERGESİ |
| 1X12 | <input type="checkbox"/> | 20 | AKIM TRAFOSU U (S1) |
| 1X13 | <input type="checkbox"/> | 21 | AKIM TRAFOSU U (S2) |
| 1X14 | <input type="checkbox"/> | 22 | AKIM TRAFOSU V (S1) |
| 1X15 | <input type="checkbox"/> | 23 | AKIM TRAFOSU V (S2) |
| 1X16 | <input type="checkbox"/> | 24 | AKIM TRAFOSU W (S1) |
| 1X17 | <input type="checkbox"/> | 25 | AKIM TRAFOSU W (S2) |

| | | | |
|------|--------------------------|----|------------------------------|
| 1X18 | <input type="checkbox"/> | 30 | JENERATÖR REFERANSI (U) |
| 1X19 | <input type="checkbox"/> | 31 | JENERATÖR REFERANSI (V) |
| 1X20 | <input type="checkbox"/> | 32 | JENERATÖR REFERANSI (W) |
| 1X21 | <input type="checkbox"/> | 0 | JENERATÖR REFERANSI NÖTR (N) |
| 1X22 | <input type="checkbox"/> | 37 | ŞEBEKE REFERANSI (R) |
| 1X23 | <input type="checkbox"/> | 38 | ŞEBEKE REFERANSI (S) |
| 1X24 | <input type="checkbox"/> | 39 | ŞEBEKE REFERANSI (T) |
| 1X25 | <input type="checkbox"/> | 0 | ŞEBEKE REFERANSI NÖTR (N) |
| 1X26 | <input type="checkbox"/> | 50 | ISITICI FAZ BESLEME |
| 1X27 | <input type="checkbox"/> | 52 | ISITICI FAZ |
| 1X28 | <input type="checkbox"/> | 0 | ISITICI NÖTR |
| 1X29 | <input type="checkbox"/> | 45 | ŞEBEKE KONTAKTÖRÜ |
| 1X30 | <input type="checkbox"/> | 46 | JENERATÖR KONTAKTÖRÜ |

NOTE : DO NOT SCALE.

| | | | | | | | |
|--|--|---|------------|---|-------|---|---------------|
| METRIC | | APPROVED BY | DATE |  | | SARAY MAH. AKSOY CAD NO:71/C KAHRAMANKAZAN / ANKARA TEL: 0312 394 05 03 MAIL: info@daspower.com.tr WEB: www.daspower.com.tr | |
| PROJECT NUMBER | | Ö.KABA | 02.03.2021 | | | | |
| PROJECT NAME | | CHECKED BY | DATE | PART DESCRIPTION KLEMENS BAĞLANTILARI | | REV A | |
| GENERAL TOLERANCES PER ISO 2768 | | Ö.KABA | 02.03.2021 | | | | |
| UNLESS OTHERWISE SPECIFIED ALL DIMENSIONS ARE IN MILLIMETERS SURFACE FINISH ARE IN MICROMETERS Ra | | DRAWN BY | DATE | SIZE | SCALE | PART NUMBER | CONFIGURATION |
| MATERIAL | | Ö.KABA | 02.03.2021 | A3 | 1:2 | | |
| WEIGHT (kg) | | THIS DOCUMENT IS PROPERTY OF GENPOWER GENERATOR INC. ALL RIGHTS ARE RESERVED. | | SHEET | 4 / 5 | | |
| FIRST ANGLE PROJECTION  | | AX NO: | | | | | |

| | | | | | |
|--------|---------------------|-----|-----|----|------|
| DOC NO | DESCRIPTION | ECO | REV | BY | DATE |
| 1 | REFERENCE DOCUMENTS | | A | | |
| 2 | REVISIONS | | | | |
| 3 | | | | | |
| 4 | | | | | |
| 5 | | | | | |
| 6 | | | | | |

1

2

3

4

5

6

A

A

B



B

C

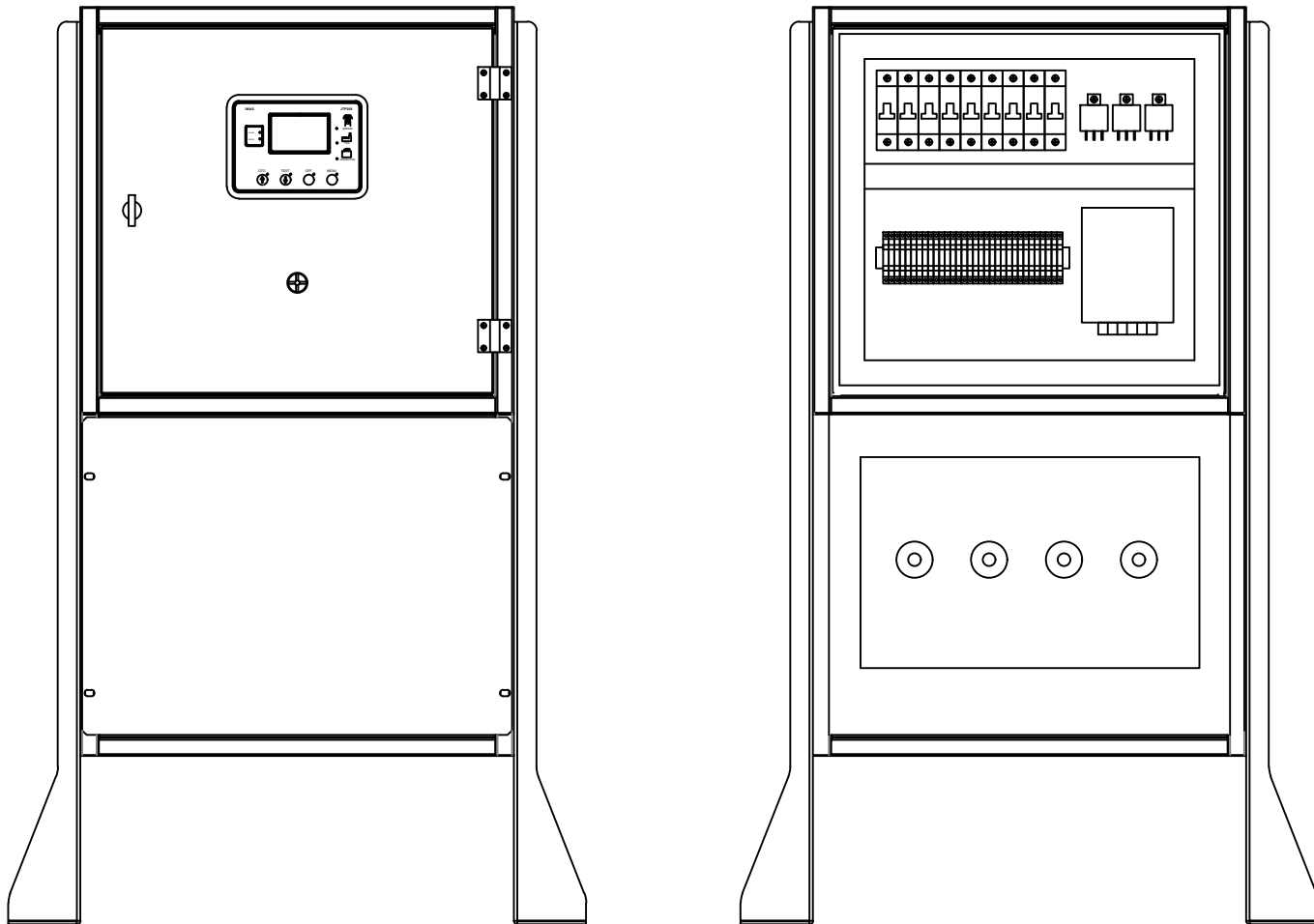
C





NOTE : DO NOT SCALE.

| METRIC | | APPROVED BY | DATE |  | SARAY MAH. AKSOY CAD NO:71/C KAHRAMANKAZAN / ANKARA TEL: 0312 394 05 03 MAIL: info@daspower.com.tr WEB: www.daspower.com.tr | | | |
|---|--|-------------|------------|--|---|-------------------|---------------------|-------------------------------------|
| PROJECT NUMBER | | Ö.KABA | 02.03.2021 | | PART DESCRIPTION KUMANDA PANOSU YERLEŞİM | SIZE A3 | SCALE 1:2 | PART NUMBER CONFIGURATION |
| PROJECT NAME | | CHECKED BY | DATE | | | | | |
| GENERAL TOLERANCES PER ISO 2768 | | Ö.KABA | 02.03.2021 | THIS DOCUMENT IS PROPERTY OF GENPOWER GENERATOR INC. ALL RIGHTS ARE RESERVED. | SHEET 5/5 | | | |
| UNLESS OTHERWISE SPECIFIED ALL DIMENSIONS ARE IN MILLIMETERS SURFACE FINISH ARE IN MICROMETERS R _a | | DRAWN BY | DATE | | | | | |
| MATERIAL | | Ö.KABA | 02.03.2021 | FIRST ANGLE PROJECTION  | | AX NO: | | |
| WEIGHT (kg) | | | | | | | | |

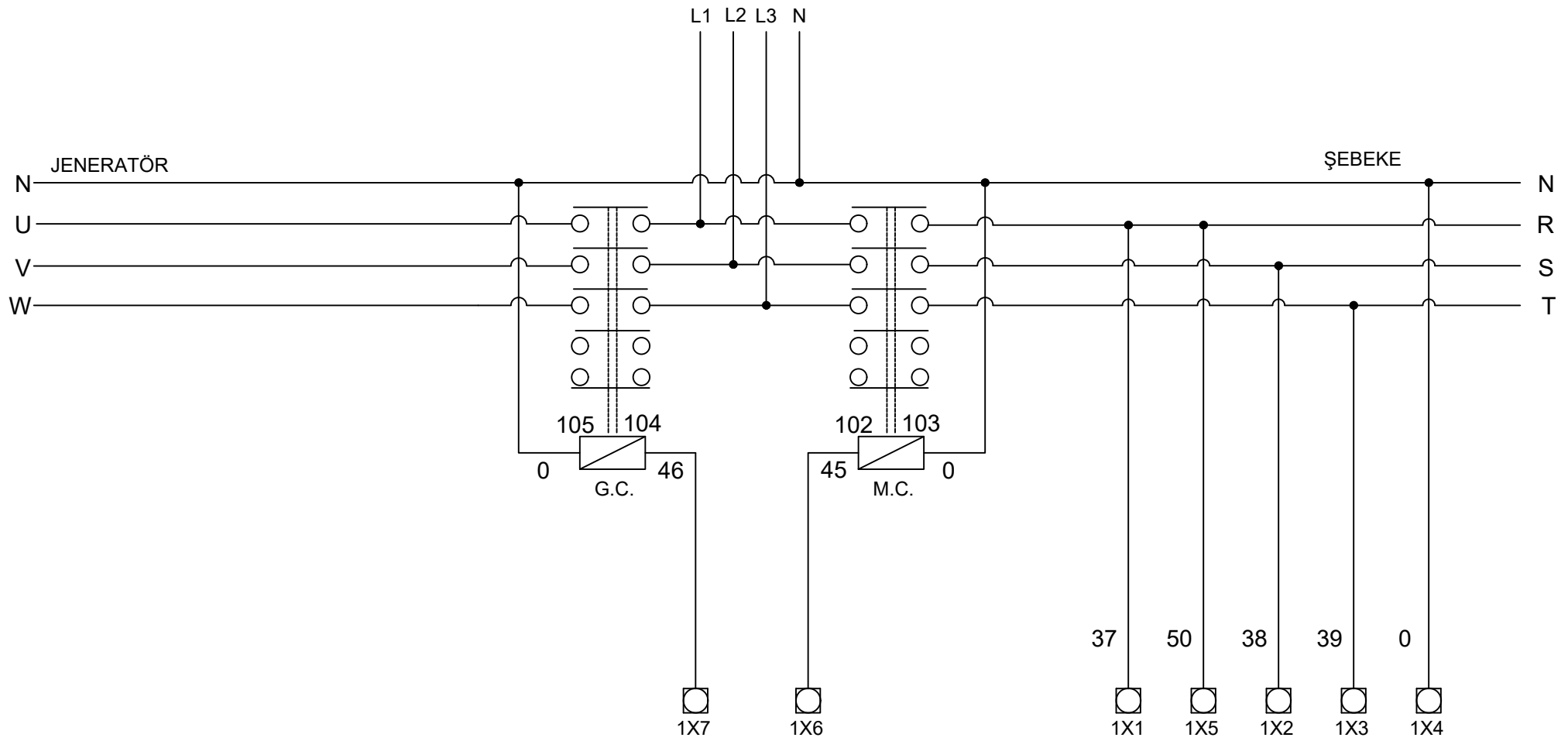
| DOC NO | DESCRIPTION | ECO | REV | BY | DATE |
|--------|-----------------------|-----|-----|----|------|
| 1 | REFERENCE DOCUMENTS | | A | | |
| 2 | YAYIMLANDI (RELEASED) | | | | |
| 3 | REVISIONS | | | | |



NOTE : DO NOT SCALE.

| | | | | | | | |
|---|--|--|--------|---|---|---------------|-----------------|
| METRIC | | APPROVED BY | DATE |  | SARAY MAH. AKSOY CAD NO:71/C KAHRAMANKAZAN / ANKARA TEL: 0312 394 05 03 MAIL: info@daspower.com.tr WEB: www.daspower.com.tr | | |
| | | PROJECT NUMBER | Ö.KABA | | | 02.03.2021 | |
| GENERAL TOLERANCES PER ISO 2768 | | CHECKED BY | DATE | PART DESCRIPTION | | | |
| | | PROJECT NAME | Ö.KABA | | | 02.03.2021 | |
| UNLESS OTHERWISE SPECIFIED ALL DIMENSIONS ARE IN MILLIMETERS SURFACE FINISH ARE IN MICROMETERS R _a | | DRAWN BY | DATE | TRANSFER PANOSU ELEKTRİK ŞEMASI | | | |
| | | MATERIAL | Ö.KABA | | | 02.03.2021 | |
| WEIGHT (kg) | | THIS DOCUMENT IS PROPERTY OF GENPOWER GENERATOR INC. ALL RIGHTS ARE RESERVED. | | SIZE | SCALE | PART NUMBER | REV A |
| | | FIRST ANGLE PROJECTION  | AX NO: | A3 | 1:2 | | |
| REFERENCE DOCUMENTS | | | | SHEET | 1/5 | CONFIGURATION | |

| DOC NO | DESCRIPTION | ECO | REV | BY | DATE |
|-----------------------|-------------|-----|-----|----|------|
| | | | A | | |
| YAYIMLANDI (RELEASED) | | | | | |
| DESCRIPTION REVISIONS | | | | | |